

MULTI-FAMILY

- Uniformity of all interior doors and frames – including stairwells and double egress frames
- Economical solution without sacrificing performance or quality
- Ideal for steel stud framing – eliminates wood blocking required when using pre-hung frames
- More durable than traditional wood frames without adding considerable cost
- Increased living space security vs wood frames
- AK frame for unit entries when using wood interior frames provides superior strength, security and fire protection when compared with wood frames

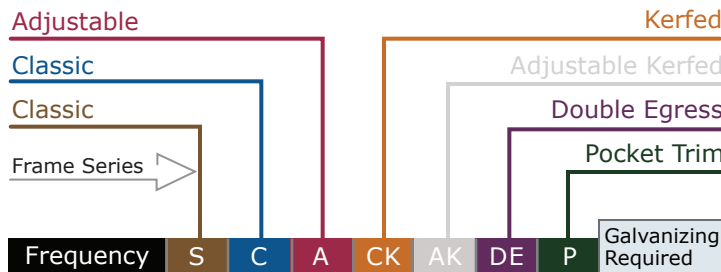

FRAME SELECTION RECOMMENDATIONS



	Frequency	Frame Series							Galvanizing Required	
		S	C	A	CK	AK	DE	P		
Common Areas	Main Entrance	H	•	•	•	•	•	•	•	H
	Secondary Entrance	M	•	•	•	•	•	•	•	H
	Corridor Offices	M	O	O	O	P	•	•	•	H
	Restrooms	M	O	O	O	P	•	•	•	Y
	Laundry	M	O	O	O	P	•	•	•	Y
	Pool	M	O	O	O	P	•	•	•	Y
	Exercise	M	O	O	O	P	•	•	•	Y
	Maintenance	L	O	O	O	P	•	•	•	H
	Meeting Rooms	L	O	O	O	P	•	•	•	H
	Interior Offices	L	P	O	O	O	•	•	•	H
	Secure Storage	L	•	P	O	•	•	•	•	H
	Mech./Elect	L	•	O	O	P	•	•	•	H
	Stairwell	L	•	O	O	P	•	•	•	H
	Corridors – Dbl. Egress	L	•	•	•	•	•	P	•	H
	Rooms	Entry	M	O	O	•	P	•	•	•
Bath		L	P	O	O	•	•	•	•	Y
Furnace		L	P	O	•	•	•	•	•	H
Bedroom		L	P	O	O	•	•	•	•	H
Closet SS/PR		L	P	O	O	•	•	•	•	H
Closet Bi-pass		L	•	P	•	•	•	•	•	H
Closet Bi-fold		L	P	O	•	•	•	•	•	H
Pocket	L	•	•	•	•	•	•	P	H	

Frequency H = High M = Medium L = Low	Use of Frame P = Preferred O = Optional • = not recommended	Galvanizing Required Y = Always H = Galvanize in Humid Climate
---	---	---

CLASSIC FRAME S C

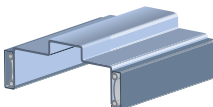

S-Series (20 gage, Factory Prefinished)
 General use for all interior openings.
 Minimum Jamb Depth – 2 1/4"
 Maximum Jamb Depth – 5 3/8"
 Fire Rating – 90 Minutes (Minimum Jamb Depth 3 3/8" for rating)
 Maximum Door Weight – 500 lbs.

C-Series (18 gage, Factory Prefinished)
 General use for all interior openings requiring additional strength and impact resistance of 18 gage steel.
 Minimum Jamb Depth – 2 1/4"
 Maximum Jamb Depth – 13"
 Fire Rating – 90 Minutes (Minimum Jamb Depth 3 3/8" for rating)
 Maximum Door Weight – 500 lbs.

ADJUSTABLE FRAME A

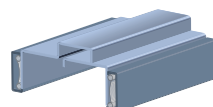

A-Series (18 gage, electro-galvanized, Factory Prefinished)
 Use for interior openings with uneven or odd sized walls requiring non-stock wall size. Adjustable jamb thickness makes this frame Ideal for remodel projects.
 Minimum Jamb Depth – 3 3/4"
 Maximum Jamb Depth – 12"
 Fire Rating – 90 Minutes
 Maximum Door Weight – 500 lbs.

MULTI-FAMILY

Accessory Hardware

- TA-10 Regular Arm Closer Reinforcement - Can be used on all Frames
- TA-12 Parallel Arm Closer Reinforcement - Classic Frames only
- TA-47 Parallel Arm Closer Reinforcement - Kerf Frames only

CASING RECOMMENDATIONS

TA-8 Steel

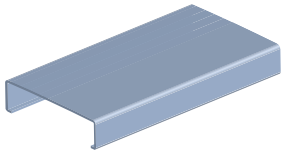
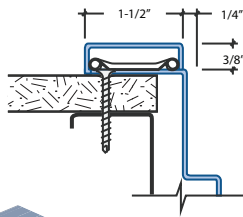

TA-30 Steel

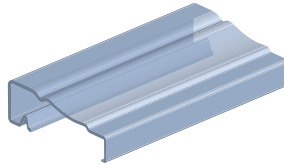
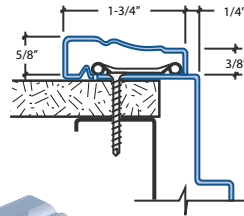

TA-35 PVC

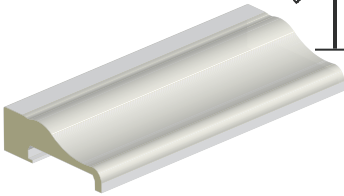
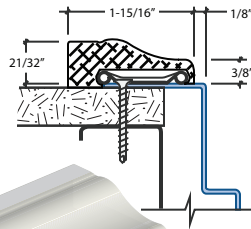

Wood Casings (supplied by others)

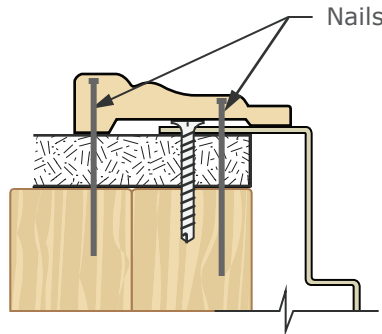

KERFED FRAME

CK

CK-Series (18 gage, electro-galvanized, Factory Prefinished)

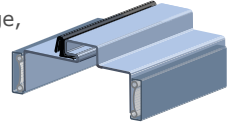

Use for interior and exterior openings requiring a seal against smoke, sound, weather, and light. Kerfed stop with factory installed seal.

Minimum Jamb Depth - 4"

Maximum Jamb Depth - 8"

Fire Rating - 90 Minutes

Maximum Door Weight - 500 lbs.

DOUBLE EGRESS FRAME

DE

DE-Series (18 gage, Factory Prefinished)

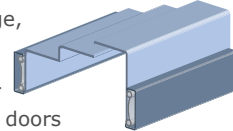

Use for cross corridor fire separation where doors are held open during normal use.

Minimum Jamb Depth - 4 3/4"

Maximum Jamb Depth - 13"

Fire Rating - 90 Minutes

Maximum Door Weight - 250 lbs.

POCKET DOOR TRIM KIT

P

P-Series (18 gage)

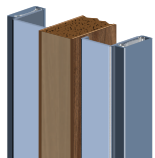

Use to trim out pocket doors so they have the same appearance as other frames for the project.

Minimum Jamb Depth - 4"

Maximum Jamb Depth - 13"

Fire Rating - none

Maximum Door Weight - N/A