

**DORMITORIES**

- Uniformity of all interior doors and frames – including stairwells and double egress frames
- Economical solution without sacrificing performance or quality
- Ideal for steel stud framing – eliminates wood blocking required when using pre-hung frames
- More durable than traditional wood frames without adding considerable cost
- Increased security vs wood frames



**FRAME SELECTION RECOMMENDATIONS**



	Frequency	Frame Series							Galvanizing Required	
		S	C	A	CK	AK	DE	P		
Common Areas	Main Entrance	H	•	•	•	•	•	•	•	H
	Secondary Entrance	M	•	•	•	•	•	•	•	H
	Corridor Offices	M	O	O	O	P	•	•	•	H
	Restrooms	M	O	O	O	P	•	•	•	Y
	Laundry	M	O	O	O	P	•	•	•	Y
	Pool	M	O	O	O	P	•	•	•	Y
	Exercise	M	O	O	O	P	•	•	•	Y
	Maintenance	L	O	O	O	P	•	•	•	H
	Meeting Rooms	L	O	O	O	P	•	•	•	H
	Interior Offices	L	P	O	O	O	•	•	•	H
	Secure Storage	L	•	P	O	•	•	•	•	H
	Mech./Elect	L	•	O	O	P	•	•	•	H
	Stairwell	L	•	O	•	P	•	•	•	H
	Corridors – Dbl. Egress	L	•	•	•	•	•	P	•	H
Rooms	Entry	M	O	O	•	P	•	•	•	H
	Bath	L	P	O	O	•	•	•	•	Y
	Furnace	L	P	O	•	•	•	•	•	H
	Bedroom	L	P	O	O	•	•	•	•	H
	Closet SS/PR	L	P	O	O	•	•	•	•	H
	Closet Bi-pass	L	•	P	•	•	•	•	•	H
	Closet Bi-fold	L	P	O	•	•	•	•	•	H
Pocket	L	•	•	•	•	•	•	P	H	

Frequency H = High M = Medium L = Low	Use of Frame P = Preferred O = Optional • = not recommended	Galvanizing Required Y = Always H = Galvanize in Humid Climate
--	--	--

**CLASSIC FRAME** S C

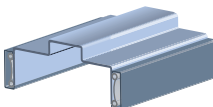
**S-Series** (20 gage, Factory Prefinished) 

General use for all interior openings.

Minimum Jamb Depth – 2 1/4"  
 Maximum Jamb Depth – 5 3/8"

Fire Rating – 90 Minutes (Minimum Jamb Depth 3 3/8" for rating)  
 Maximum Door Weight – 500 lbs.

**C-Series** (18 gage, Factory Prefinished)

General use for all interior openings requiring additional strength and impact resistance of 18 gage steel.

Minimum Jamb Depth – 2 1/4"  
 Maximum Jamb Depth – 13"

Fire Rating – 90 Minutes (Minimum Jamb Depth 3 3/8" for rating)  
 Maximum Door Weight – 500 lbs.

**ADJUSTABLE FRAME** A

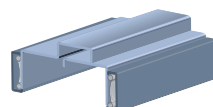
**A-Series** (18 gage, electro-galvanized, Factory Prefinished) 

Use for interior openings with uneven or odd sized walls requiring non-stock wall size. Adjustable jamb thickness makes this frame Ideal for remodel projects.

Minimum Jamb Depth – 3 3/4"  
 Maximum Jamb Depth – 12"

Fire Rating – 90 Minutes  
 Maximum Door Weight – 500 lbs.

**DORMITORIES**

**Accessory Hardware**

- TA-10 Regular Arm Closer Reinforcement - Can be used on all Frames
- TA-12 Parallel Arm Closer Reinforcement - Classic Frames only
- TA-47 Parallel Arm Closer Reinforcement - Kerf Frames only

**CASING RECOMMENDATIONS**

**TA-8 Steel**

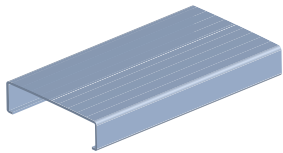
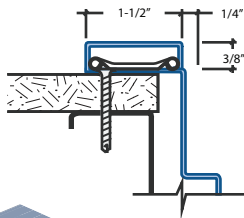

**TA-30 Steel**

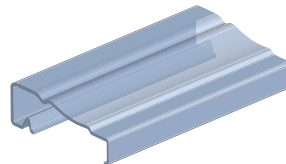
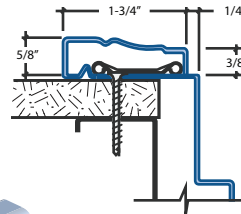

**TA-35 PVC**

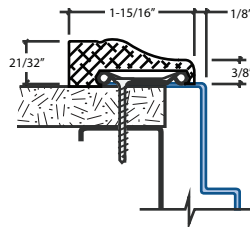
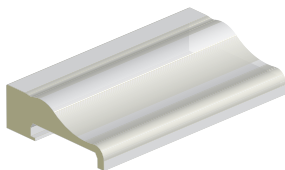

**KERFED FRAME**

**CK**

**CK-Series** (18 gage, electro-galvanized, Factory Prefinished)

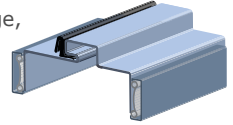

Use for interior and exterior openings requiring a seal against smoke, sound, weather, and light. Kerfed stop with factory installed seal.

Minimum Jamb Depth - 4"

Maximum Jamb Depth - 8"

Fire Rating - 90 Minutes

Maximum Door Weight - 500 lbs.

**DOUBLE EGRESS FRAME**

**DE**

**DE-Series** (18 gage, Factory Prefinished)

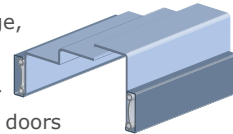

Use for cross corridor fire separation where doors are held open during normal use.

Minimum Jamb Depth - 4 3/4"

Maximum Jamb Depth - 13"

Fire Rating - 90 Minutes

Maximum Door Weight - 250 lbs.

**POCKET DOOR TRIM KIT**

**P**

**P-Series** (18 gage)

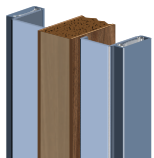

Use to trim out pocket doors so they have the same appearance as other frames for the project.

Minimum Jamb Depth - 4"

Maximum Jamb Depth - 13"

Fire Rating - none

Maximum Door Weight - N/A