

BUILDINGS OF WORSHIP

- Perfect blend of strength, design and performance provided at a greatly reduced total opening cost
- Easily adapted to use custom millwork and casing options while maintaining strength and fire protection of steel
- Ideal for either wood stud or steel stud framing
- Fire rated sidelights and borrowed lights available



FRAME SELECTION RECOMMENDATIONS



Common Areas	Frequency	S	C	A	CK	AK	DE	P	Galvanizing Required
	Main Entrance	H	•	•	•	•	•	•	•
Secondary Entrance	M	•	•	•	•	•	•	•	H
Corridor Offices	M	O	O	O	P	•	•	•	H
Interior Offices	L	P	O	O	O	•	•	•	H
Restrooms	M	P	O	O	O	•	•	•	Y
Meeting Rooms	L	O	O	O	P	•	•	•	H
Mechanical/Electric	L	•	O	O	P	•	•	•	H
Secure Storage	L	•	P	O	•	•	•	•	H
Closet SS/PR	L	P	O	O	•	•	•	•	H
Stairwell	L	•	O	•	P	•	•	•	H
Sidelight		•	P	•	•	•	•	•	H
Borrowed Light		O	P	O	•	•	•	•	H
Corridors - Dbl Egress	L	•	•	•	•	•	P	•	H
Cry Room	L	O	O	O	P	•	•	•	H
Sanctuary	M	O	O	O	P	•	•	•	H
Choir Room	M	O	O	O	P	•	•	•	H

Frequency H = High M = Medium L = Low	Use of Frame P = Preferred O = Optional • = not recommended	Galvanizing Required Y = Always H = Galvanize in Humid Climate
---	---	---

CLASSIC FRAME S C

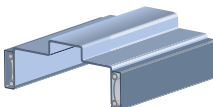
S-Series (20 gage, Factory Prefinished) 

General use for all interior openings.

Minimum Jamb Depth – 2 1/4"

Maximum Jamb Depth – 5 3/8"

Fire Rating – 90 Minutes (Minimum Jamb Depth 3 3/8" for rating)

Maximum Door Weight – 500 lbs.

C-Series (18 gage, Factory Prefinished)

General use for all interior openings requiring additional strength and impact resistance of 18 gage steel.

Minimum Jamb Depth – 2 1/4"

Maximum Jamb Depth – 13"

Fire Rating – 90 Minutes (Minimum Jamb Depth 3 3/8" for rating)

Maximum Door Weight – 500 lbs.

ADJUSTABLE FRAME A

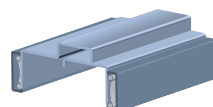
A-Series (18 gage, electro-galvanized, Factory Prefinished) 

Use for interior openings with uneven or odd sized walls requiring non-stock wall size. Adjustable jamb thickness makes this frame Ideal for remodel projects.

Minimum Jamb Depth – 3 3/4"

Maximum Jamb Depth – 12"

Fire Rating – 90 Minutes

Maximum Door Weight – 500 lbs.

BUILDINGS OF WORSHIP

Accessory Hardware

- TA-10 Regular Arm Closer Reinforcement - Can be used on all Frames
- TA-12 Parallel Arm Closer Reinforcement - Classic Frames only
- TA-47 Parallel Arm Closer Reinforcement - Kerf Frames only

CASING RECOMMENDATIONS

TA-8 Steel

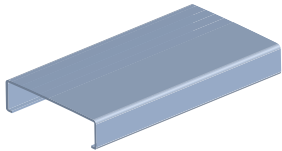
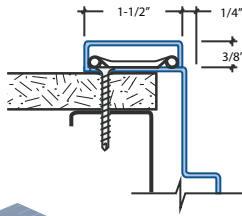

TA-30 Steel

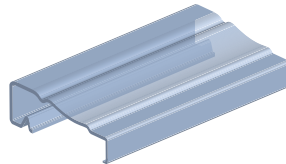
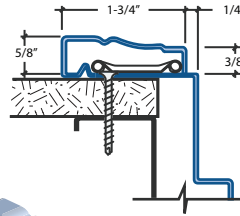

TA-35 PVC

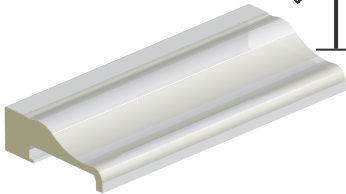
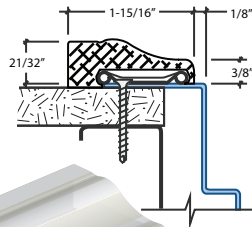

Wood Casings (supplied by others)

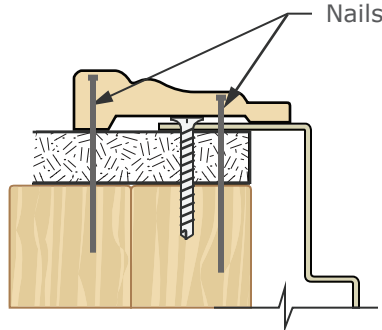

KERFED FRAME

CK

CK-Series (18 gage, electro-galvanized, Factory Prefinished)

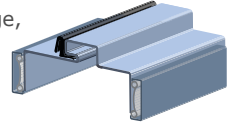

Use for interior and exterior openings requiring a seal against smoke, sound, weather, and light. Kerfed stop with factory installed seal.

Minimum Jamb Depth - 4"

Maximum Jamb Depth - 8"

Fire Rating - 90 Minutes

Maximum Door Weight - 500 lbs.

DOUBLE EGRESS FRAME

DE

DE-Series (18 gage, Factory Prefinished)

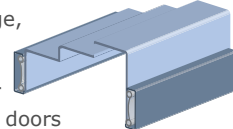

Use for cross corridor fire separation where doors are held open during normal use.

Minimum Jamb Depth - 4 3/4"

Maximum Jamb Depth - 13"

Fire Rating - 90 Minutes

Maximum Door Weight - 250 lbs.